

# Metal X Design Reference Sheet

Listed dimensions are as designed for your final part unless otherwise specified. These guides serve as recommendations and may not reflect all implementations, since 3D printing is a geometry dependent process.

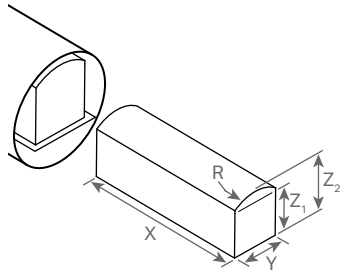

## Maximum Part Size with Sinter-1

**X: 235.0 mm (9.25")**

**Y: 68.3 mm (2.69")**

**Z<sub>1</sub>: 65.5 mm (2.58")**

**Z<sub>2</sub>: 80.0 mm (3.19")**

**R: 55.5 mm (2.18")**

These are the maximum post-sintered dimensions of a part made with the Metal X system using the Sinter-1. This includes scaling factors, the part raft, and the setter tray. Software limits parts to a bounding box of X, Y, Z<sub>1</sub>. Due to the shape of the Sinter-1 tube, taller parts can extend up to Z<sub>2</sub> in height if their top surface fits within a radius of R centered along the part.

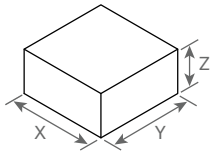

## Minimum Part Dimensions

**X: 2.0 mm (0.079")**

**Y: 2.0 mm (0.079")**

**Z: 1.3 mm (0.049")**

Minimum part size is limited to the extrusion width and height of each bead. The dimensions are derived from the minimum number of roof layers, floor layers, and shells needed to print a part successfully.

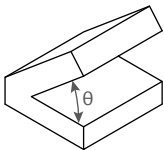

## Maximum Unsupported Overhang

**θ: 45°**

This is the minimum angle to the horizontal at which a feature of a part can print without needing supports to hold it up. Eiger will generate supports for all overhangs with angles below 45°.

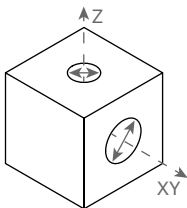

## Minimum Hole Diameter

**XY: 1.5 mm (0.059")**

**Z: 1.0 mm (0.039")**

Holes with too small a diameter may close off during printing or print inaccurately. Horizontal surface holes (Z) print more precisely than vertical surface holes (XY).

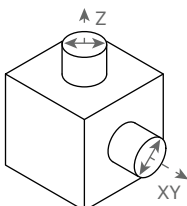

## Minimum Post Diameter

**XY: 3.0 mm (0.118")**

**Z: 3.0 mm (0.118")**

Posts with too small a diameter may not print or sinter precisely. Consider adding fillets to the bases of posts to reduce the potential for shearing in the green state.

# Metal X Design Reference Sheet

## Minimum Engraved Features

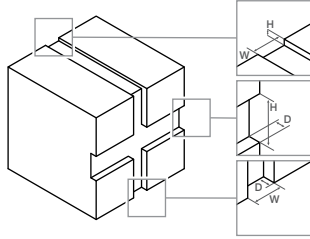

### Z Layer features

H: 0.13 mm (0.005")

W: 0.50 mm (0.019")

### Horizontal XY features

H: 1.5 mm (0.059")

D: 0.5 mm (0.019")

### Vertical XY features

W: 0.5 mm (0.019")

D: 0.5 mm (0.019")

An engraved feature is one that is recessed below the surface of the model. Common examples include lettering and texture. Engraved features may blend into the rest of the model if they are too small.

## Minimum Embossed Features

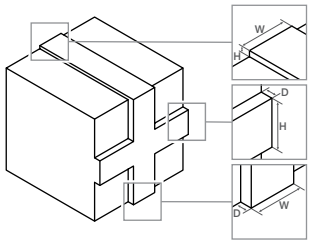

### Z Layer features

H: 0.13 mm (0.005")

W: 1.0 mm (0.039")

### Horizontal XY features

H: 1.3 mm (0.049")

D: 0.5 mm (0.019")

### Vertical XY features

W: 1.0 mm (0.039")

D: 0.5 mm (0.019")

An embossed feature is one that is raised above the surface of the model. Common examples include lettering and texture. Embossed features may blend into the rest of the model if they are too small.

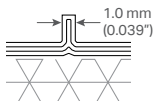

**Important note:** To prevent gaps in features less than 2.0 mm (0.079") wide, design embosses to be even multiples of 0.25 mm (0.01"), the width of a single post-sintered extrusion of metal.

# Optimize For Printing

As you design your part, consider how it can be optimized for the printing process. Below are four considerations to keep in mind when designing:

## 1. Identify Critical Dimensions

3D printers have higher precision in planes parallel to the build plate. What are your critical dimensions or features?

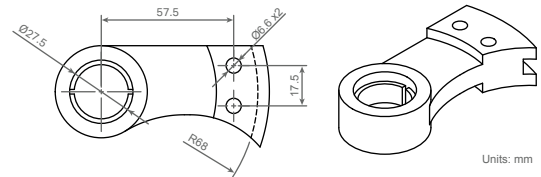

## 2. Maximize Bed Contact

Greater surface area on the print bed minimizes supports and improves bed adhesion. Which face of your part contacts the bed?

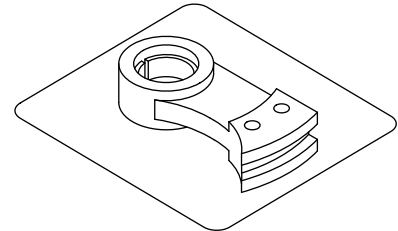

## 3. Reduce Supports

Fewer supports reduce printing and processing time. How can you design to minimize supports? Are the supports in your part accessible?

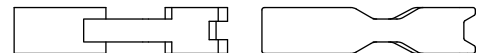

## 4. Consider Batch Processing

The more parts you can pack into a sintering run, the lower batch cost you have per part. How will your part pack among others in the furnace?

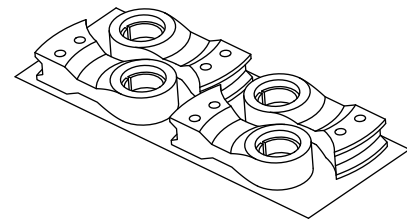

## Modify Overhangs to Optimize Supports

Supports are necessary to prevent overhang collapse during printing and sintering. Consider where your parts will require supports and what you can do to minimize supports to decrease print time. Ensure the supports on your part are easy to access and remove before you print. If not, consider modifying overhangs to improve support removal.

### Eliminate Supports

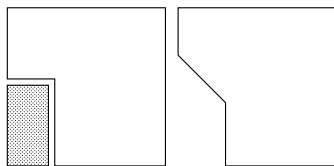

Chamfer small overhangs at 45°

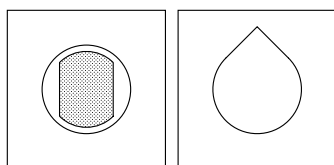

Teardrop XY holes to clear channels

### Simplify Support Removal

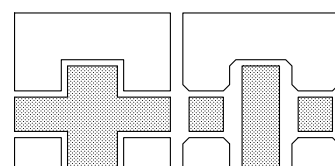
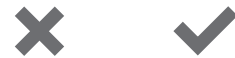

Break up supports with 45° chamfers on edges

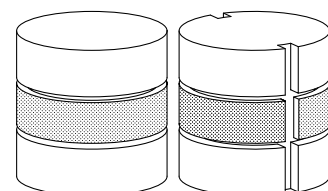

Add slits to separate segments

# Optimize For Washing

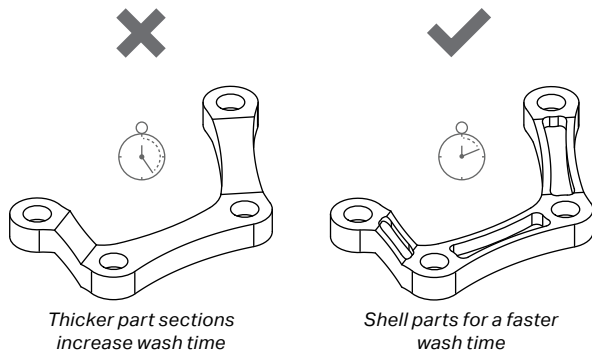

## Shell Out Thick Parts

The thicker your part is, the longer it will take to wash. Shell out large volumes and increase surface area to minimize the time your parts spend in the wash. Try to maintain consistent wall thickness across your part.

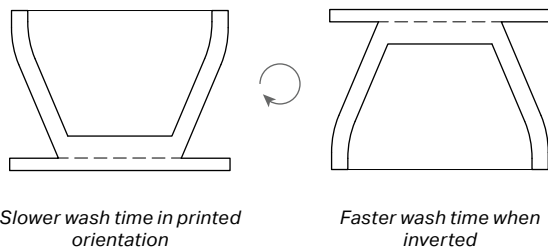

## Wash Bowls Upside Down

Wash bowl-shaped parts upside down (no need to change print orientation) because the washing solvent is lighter than the binder material. When upside-down, the solvent permeates up into the bowl, resulting in a faster wash time.

# Optimize For Sintering

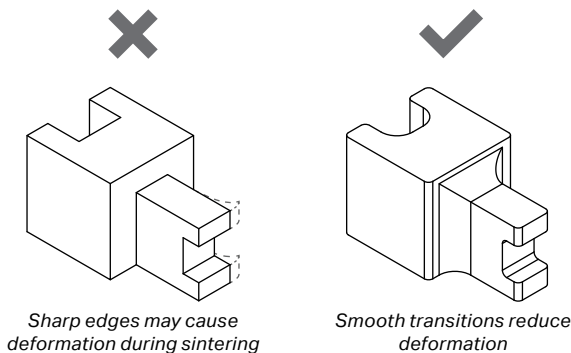

## Reduce Stress Concentrations

Parts undergo thermal stresses when sintering because they are pulling themselves together as they shrink. Reduce stress concentrations by filleting your edges and designing gradual instead of sharp changes in thickness.

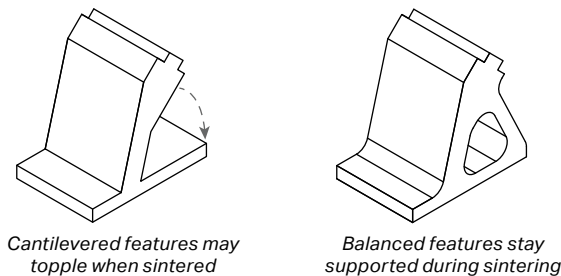

## Ensure Features are Well Balanced

As parts go through the sintering process, the heat induces a clay-like state that makes them malleable. If your parts don't need supports, ensure they are inherently stable in their printed orientation. Avoid top-heavy, cantilevered, or tall and thin features.

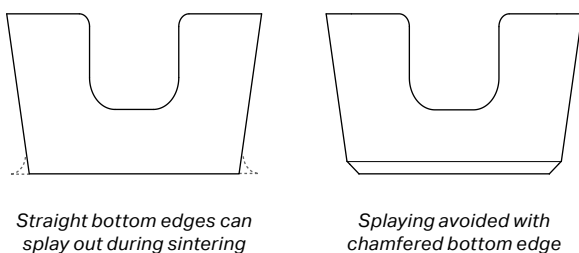

## Chamfer Bottom Edges

The bottom edge of your part may splay out during sintering. Adding a 0.5-1.0 mm (0.02"-0.04") chamfer to the bottom edges of your part will prevent splayed edges, especially on small features like holes and channels.

# Strategic Metal Printing Practices

Think critically about what aspects of your design need to be 3D printed. Some features could be implemented more efficiently with other manufacturing methods. When appropriate, integrate other parts into your design to save on print time, design complexity, and cost. Below are some examples:

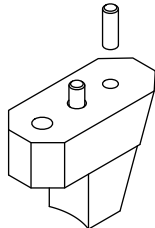
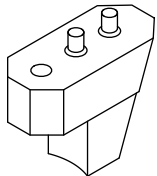

## Use Pins for Alignment Features

Improve alignment precision and save material and print time by pressing dowel pins into your parts or using shoulder bolts for location. Dowel pins pressed into this gripper jaw locate it on a robotic arm. This design change reduces supports and simplifies print orientation.

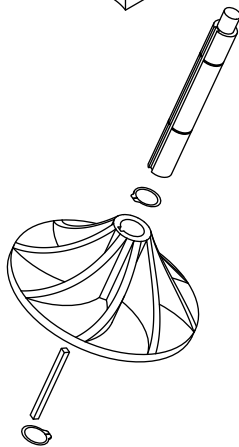
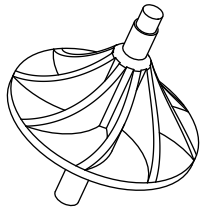

## Separate Printed from Simple Features

Isolate complex part features for metal 3D printing. Printing an impeller with an integrated shaft will sacrifice optimal print orientation for furnace orientation — it can only fit in the Sinter-1 sideways. Instead, the impeller can be printed apart from a turned shaft to decrease print time and part complexity. The retaining rings locate the impeller on the shaft, and the key acts as a shear point that can be swapped if it fails.

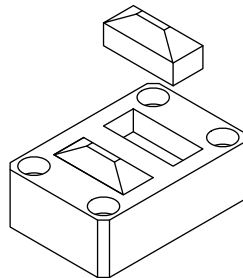
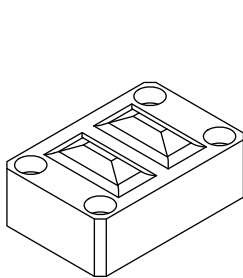

## Isolate Properties with Modular Features

This sheet metal stamp consists of a blank with metal printed inserts. Isolating the metal inserts as separate parts localizes metal properties to only the region they are required, so you don't need to print an entirely new tool for every revision. This also makes maintenance and tool repair easy.

## DON'T PRINT YOUR HARDWARE

Printing hardware is a poor use of the Metal X technology — purchasing off-the-shelf hardware is almost always more cost- and time-efficient and produces better results. Hardware like bushings, bearings, and springs are produced with specialized manufacturing processes and will not behave the same way when printed. Washers, nuts, bolts, and similar hardware are cheaper and more effective to purchase than to print.

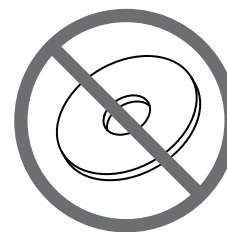
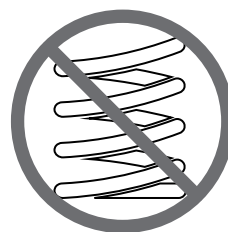
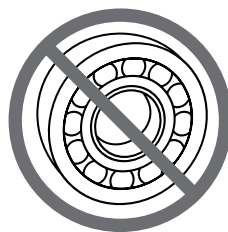
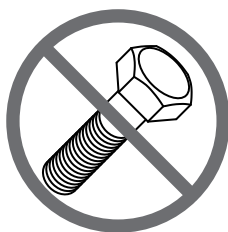

# Post-Processing Metal Parts

## Green State Sanding

Wet sanding green parts under warm water with 240-320 grit sandpaper or Scotch-Brite leaves a matte finish once sintered. Green parts are fragile, so be cautious as any modifications may affect precision or sintering performance. Sand over a receptacle or filter to prevent sink clogging, and use proper PPE.

## Machining and Polishing Sintered Parts

The diagram on the right serves as a recommendation for post-processing parts to remove layer-line deviations without running the risk of exposing infill. Offset faces you wish to machine in your design so that when material is removed you can meet your tolerances.

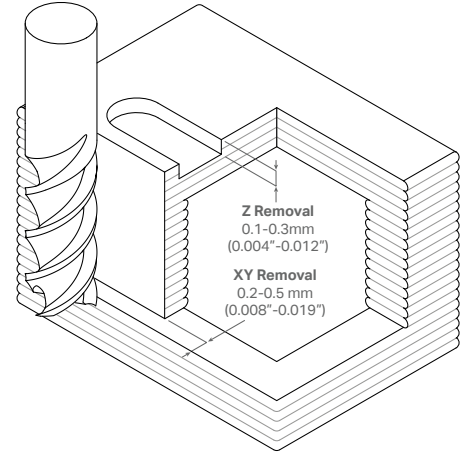

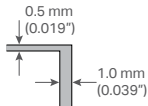

**Important note:** Printed metal parts have a wall thickness of 1.0 mm (0.039") and a roof and floor thickness of 0.5 mm (0.019"). When post-processing parts, don't remove more than this much or you will cut through the shells entirely and expose infill.

## Threads

### Tapped Threads

Tapped threads will be tighter tolerance than printed threads. Use 50% thread engagement for your tapped hole size in steels and other hard metals.

### Printed Threads

Printed threads may need to be chased with a tap or need lapping compound for an even thread.

### Vertical Threads

Tap vertical threads less than M3 (or #5-40)

Print or tap threads between M3 (or #5-40) and M10 (or 3/8"-16)

Print vertical threads larger than M10 (or 3/8"-16)

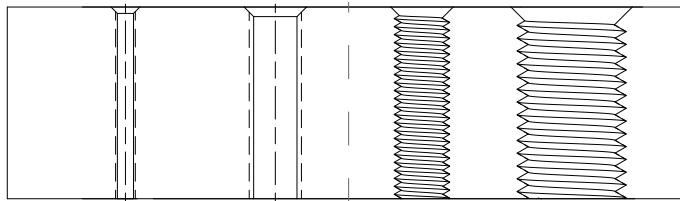

### Angled and Horizontal Threads

Tap angled and horizontal threads less than M8 (or 5/16"-18)

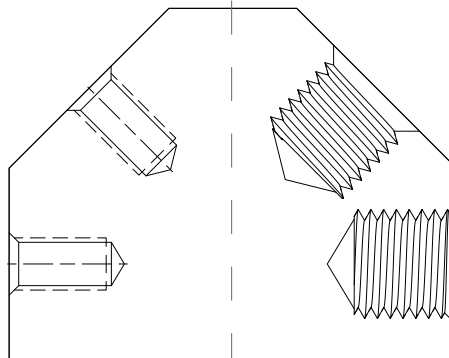

Print angled and horizontal threads larger than M8 (or 5/16"-18)

Some metal printed parts may be difficult to fixture for machining or tapping due to their complex geometry. You can use Markforged composite printers to create conformal workholding to hold the metal parts in these cases.

# Metal Selection and Treatment

Below we list the main properties and applications of each metal we have available for the Metal X system, along with a summary of heat treatment for each material. Heat treating primarily alters the ductility, toughness, hardness, and strength of a metal part. Those treated at higher temperatures typically have lower strength and hardness, but higher ductility and toughness. While specific properties may vary depending on part size and complexity, parts in the annealed condition have the highest ductility and are easiest to work with. For more specific details, reference our data sheet or other heat treating guides.

## 17-4 PH Stainless Steel

17-4 PH Stainless Steel is a common martensitic stainless steel characterized by high strength and excellent corrosion resistance. The material can be precipitation hardened to adjust mechanical properties to fit your application. This easy-to-weld, versatile steel is widely used in the metalworking, aerospace, petrochemical, and medical industries.

### Heat Treatment Information

Post-sintered 17-4 PH Stainless Steel is in a near-annealed state that can be easily worked with. Annealing to Condition A is only necessary if a part needs re-treatment.

**Heat Treatment:** Heat the part to the temperature and for the time span listed in the table to the right based on the desired condition. Post-sintered 17-4 does not need annealing prior to treatment. All parts should be air cooled.

Condition	Heat To °F (°C)	Time at Temp.	Yield Strength MPa	Elongation % in 2"	Hardness Rc
A	1950 (1066)	30 min	760	5	34
H900	900 (482)	1 hr	1170	10	40
H925	925 (496)	4 hrs	1070	10	38
H1025	1025 (551)	4 hrs	1000	12	35
H1075	1075 (580)	4 hrs	860	13	32
H1100	1100 (593)	4 hrs	795	14	31
H1150	1150 (621)	4 hrs	725	16	28
H1150-M	1400 (760) <i>followed by</i> 1150 (621)	2 hrs <i>followed by</i> 4 hrs	520	18	24

Material data reflects typical values for wrought materials. Printed part properties may differ.

## H13 Tool Steel

H13 Tool Steel is a hot-work class steel characterized by high temperature hardness and abrasion resistance. It's tough, impact resistant, and easy to machine and polish. H13 is resistant to thermal fatigue and premature heat-checking, and has excellent through-hardening properties, making it a great fit for molding applications like inserts, cores, and dies.

### Heat Treatment Information

**1. Anneal:** H13 is not annealed when sintered and will need to be before heat treatment or machining. Heat the part to 1553-1652°F (845-900°C) at 400°F (222°C) per hour and hold at temperature for one hour per inch of maximum part thickness. Cool slowly at a rate not exceeding 50°F (28°C) per hour until 1000°F (538°C), then continue cooling in air. The hardness of annealed material should be around 90-95HRB.

**2. Preheat:** Use a double preheat to minimize distortion by heating the part at 400°F (204°C) per hour to 1100-1250°F (593-677°C) and letting the part equalize, then heat to 1500-1600°F (816-871°C) and equalize again.

**3. Austenitize:** Heat rapidly to 1800-1890°F (982-1032°C) and hold for 30 minutes to 2 hours. Use a salt bath or controlled atmosphere furnace to minimize decarburization.

**4. Quench:** Quench the part in still air. Temper immediately after quenching. You may use an interrupted oil quench to below 150°F (65°C) on large parts or to maximize hardness and toughness, but there is some risk of cracking during the process.

**5. Temper:** Temper at a minimum of 50°F (28°C) above the maximum operating temperature of the part, using the table to the right as a guide. Temper at one hour per inch of maximum part thickness for at least two hours. A second temper at 25-50°F (14-28°C) below the first is recommended, especially when heat checking is a problem.

Temper To °F (°C)	Hardness Rc
900 (482)	54
1000 (538)	52
1050 (566)	50
1100 (593)	46
1150 (621)	36
1200 (649)	30
As Sintered	40

Material data reflects typical values for wrought materials. The following were referenced in creating these guides:

17-4 PH Stainless Steel:  
ASTM A 564/A 564M: Standard Specification for Hot-Rolled and Cold-Finished Age-Hardening Stainless Steel Bars and Shapes

Specialty Steel Supply: [specialtysteelsupply.com/brochure/17-4-technical-data.pdf](http://specialtysteelsupply.com/brochure/17-4-technical-data.pdf)

AK Steel: [aksteel.com/sites/default/files/2018-01/174ph201706.pdf](http://aksteel.com/sites/default/files/2018-01/174ph201706.pdf)

H13 Tool Steel:  
ASTM A681: Standard Specification for Tool Steels Alloy

Hudson Tool Steel: [hudsontoolsteel.com/technical-data/steelH3](http://hudsontoolsteel.com/technical-data/steelH3)

Cincinnati Tool Steel Company: [cintool.com/documents/mold\\_quality/H13.pdf](http://cintool.com/documents/mold_quality/H13.pdf)